

Varenummer: 20146B60802SW
 Beskrivelse: E+G
 Flange rørholder GN 146-B60-80-2-SW

Mål

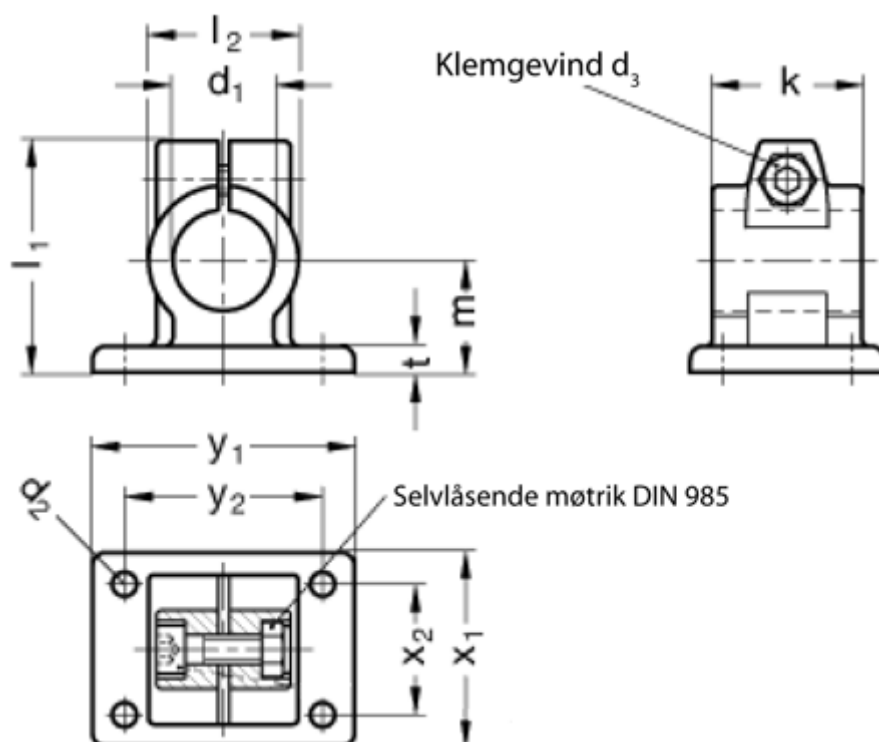

$d_1 = B60$	Vippehåndtag = GN 911-M10-55 skal bestilles separat
$d_2 = 11.0$	$x_1 = 110$
$d_3 = M10$	$x_2 = 74$
$k = 80$	$y_1 = 154$
$l_1 = 102$	$y_2 = 118$
$l_2 = 80$	
$m = 60$	
$t = 14$	